

Decking // Fencing // Privacy screen

EasyDeck[®]
Made in Germany



A material
as diverse as
nature itself.

GCC
German Compact Composite



www.easydeck.de/en



One material.
Two versions.

GCC

German Compact Composite

GCC (German Compact Composite) is a wood-polymer material that is a true all-rounder. Up to **75% of wood** fibres are supplemented with environmentally friendly additives and with polymers in a patented process. It is particularly important to us that the number of harmless additives used to supplement wood in our products are limited to what is unavoidable. The material produced in the heart of Germany is **PVC-free, healthy and circulated within a closed loop system**. We deliberately dispense with chemical sealing, instead relying on the natural product's intrinsic protection.

Some of our products have recycled synthetic resin added to the material formulation. This material is produced, among other things, from end-of-life wind turbine rotor blades. This material version allows us to achieve very specific product properties while at the same time making us pioneers in the material recycling of rotor blades.



GCC *HOLZart*

Our wood-fibre content
is up to 75%.

GCC HARZart replaces part of the ingredients with synthetic resins, among other things produced from recycled turbine rotor blades. The material derives its name from these resins. Combined with our unique manufacturing process, this leads to a particularly dense and less hygroscopic material that can be used in many different outdoor applications. The synthetic resin content makes this material version seem cool and smooth, while feeling warm and particularly pleasant when in contact with the skin.

- // with at least 50% wood fibres from sustainably managed forests and up to 30% recycled synthetic resin
- // harder and heavier than hardwood
- // stores heat better than wood, heats up significantly less than natural stone, concrete or ceramics
- // can be further processed by sawing or drilling

It looks like wood, feels like wood, and smells like wood. Our polymer-bonded wood material has all the advantages of the natural material. It feels warm and is easy to process. The Addition of polymers and additives turns the original softwood into a solid, durable wood material that can withstand the high demands of outdoor use following extrusion – without any plastic coating at all.

- // contains up to 75% wood fibres from sustainably managed forests
- // harder and heavier than hardwood
- // stores heat better than wood, heats up significantly less than natural stone, concrete or ceramics
- // can be further processed by sawing, drilling, sanding or planing



GCC *HARZart*

With more than 50% wood
fibre content and up to 30%
recycled synthetic resin.

You will find returns dealers here:
www.easydeck.de/en/dealer



GCC HOLZart
 Initial enrichment with chips and polymers



GCC HARZart
 Initial enrichment with chips, polymers, and recycled synthetic resin, e.g., from used wind turbine rotor blades



Extrusion of new EasyDeck® products



Use of new EasyDeck® products



Further processing to create GCC granules

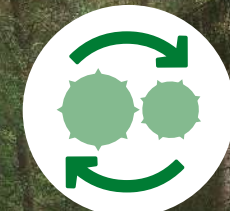

Processing of old EasyDeck® products



Returning of old EasyDeck® products to the dealer



Taking back by NOVO-TECH

Our understanding of sustainability.

If anything is certain to lie in our genes, then it is the Cradle to Cradle® principle. This describes material cycles in which products and raw materials respectively, always circulate recurringly – no waste exists. We operate special systems for since 2005 so that we can consistently implement this recycling economy. This enables us to receive and use existing material resources without a loss of quality, in addition to being able to expand and manufacture products of the highest quality standard - without an additional consumption of natural raw materials.

Join us in shaping a future worth living for future generations and return your EasyDeck® products at the end of their useful life to a take-back dealer near you. Simply scan the QR code on the left to visit the dealer locator on our website.

- // use of shavings from sustainably managed PEFC-certified European forests
- // climate-positive production with renewable energies
- // closed material cycle for permanent storage of carbon in the wood
- // better raw material conservation
- // our products meet the criteria for sustainable construction and Green Building in accordance with the DGNB system, LEED® and BREEAM®



Cradle to Cradle certified

Both GCC material versions are designed to meet the extreme high requirements of the Cradle to Cradle®-principle and are certified by the Cradle to Cradle Certified® Products Innovation Institute at Cradle to Cradle Certified® Gold level*, with GCC HOLZart even achieving the highest level of Platinum in material health. This makes GCC one of the few building materials worldwide to achieve this level and whose ingredients have been proven to be materially healthy and ecotoxicologically harmless. Evaluation of the integrated water management and climate-positive energy concept in production as well as the high social standards at our production site in Germany round off the comprehensive material and process evaluation. GCC meets the highest standard for eco-effectiveness. The certification proves our products' contribution to the positive sustainability rating of buildings.

	BRONZE	SILVER	GOLD	PLATINUM
Material Health*			✓	✓
Product Circularity			✓	
Clean Air & Climate Protection			✓	
Water & Soil Stewardship			✓	
Social Fairness			✓	

The certification proves that our products make a contribution to the positive sustainability evaluation of buildings.

*GCC HOLZart achieves PLATINUM, GCC HARZart achieves GOLD in material health. Cradle to Cradle Certified® is a registered trademark of the Cradle to Cradle Products Innovation Institute. More information about the certification www.easydeck.de/en

Honest German quality.

Products made of GCC are highly resistant due to the high natural fibre content and have a low thermal expansion. Natural processes change the colouring and feel over time since our material is based on wood. About 20 years of experience and development support this material. We only promise what we can deliver!

Independently certified

We strive to offer consistent quality and impeccable products without any worries at all times. Various seals of approval from independent testing institutes confirm our product claim. In addition to being Cradle to Cradle Certified® to the gold level, demonstrating the material health and recyclability of products, EasyDeck® meets, among other things, the high requirements of the Qualitätsgemeinschaft Holzwerkstoffe e. V. quality seal. Apart from this, the PEFC-certificate confirms that our wood fibres are produced from sustainably managed forests.



Tested in our in-house laboratory

We don't simply rely on the results provided by external bodies but analyse our materials in-depth on our own in our in-house laboratory as well: We keep on checking that all raw material samples and our finished products alike meet our strict specifications. Modern laboratory technology enables us to verify that all ingredients used are free from harmful substances. We can simulate a number of weather and stress situations in order to provide you with a long-lasting product with a clear conscience.



Promises of our EasyDeck® products:

- // Material with high wood content – no PVC
- // Very hard, resistant surface
- // Coloured material
- // Solid products – no hollow section
- // Amazingly thin – highly resilient
- // Long-term user experience
- // Resistant to salt and chlorine
- // Easy processing
- // Systematic laying
- // Pleasant barefoot feeling – excellent surefootedness
- // Low brittleness, does not splinter
- // Healthy living through certified harmlessness
- // They fulfil the requirements of DIN EN 71-3 and are therefore suitable for the production of children's toys

No more
splinter worries!

EasyDeck® Dolomit 16x193

16 mm thick deck board,
in four colours, 193 x 3000, 4000 or 5000 mm**



The extra wide deck board with a vivid interplay of colours and wood character.

Do you appreciate the visual appearance of wood and the unique colour gradient that the natural product is able to provide? Then our Dolomit 16x193 board is the right choice for you! The structured, polished surface as well as the gentle interplay of colours ensure a harmonious concept. Introduce a wood character to your terrace and beneath your feet.

- // Surface: Structured with colour gradient and polished
- // Can be laid on one side
- // Gap width: 5 mm (± 0.5 mm)
- // Material: **GCC HOLZart**

Natural colour development

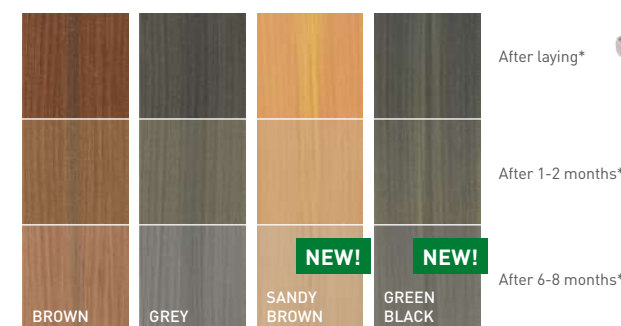

*The figures illustrate an example of the colours available for delivery and their natural colour development process



Great feel.
Smart look!



EasyDeck® Glacier 16x193

16 mm thick deck board,
in two colours, 193 x 3000 or 4000 mm



The figure illustrates the EasyDeck® Glacier product in graphit

The extra wide deck board with wooden character or finely corrugated design.

Boards from the Glacier range are characterised by the mix of two varying sides. As it can be laid on both sides, the Glacier 16x193 board boasts a finely corrugated surface on one side and a surface with wood character on the other. Randomly placed, curved structures give the surface a visual dynamic. The extra wide deck boards are available for purchase in terra and graphit and are a real eye-catcher as well!

- // Surface: Finely corrugated or structured
- // Can be laid on both sides
- // Gap width: 8 mm (± 0.5 mm)
- // Material: **GCC HOLZart**

Natural colour development

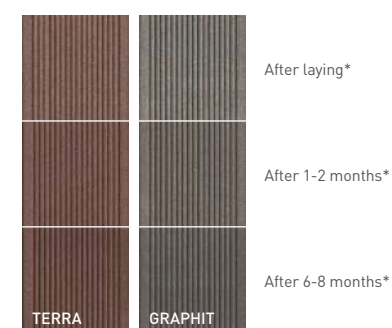

*The figures illustrate an example of the colours available for delivery and their natural colour development process



*A wow factor
every single day!*

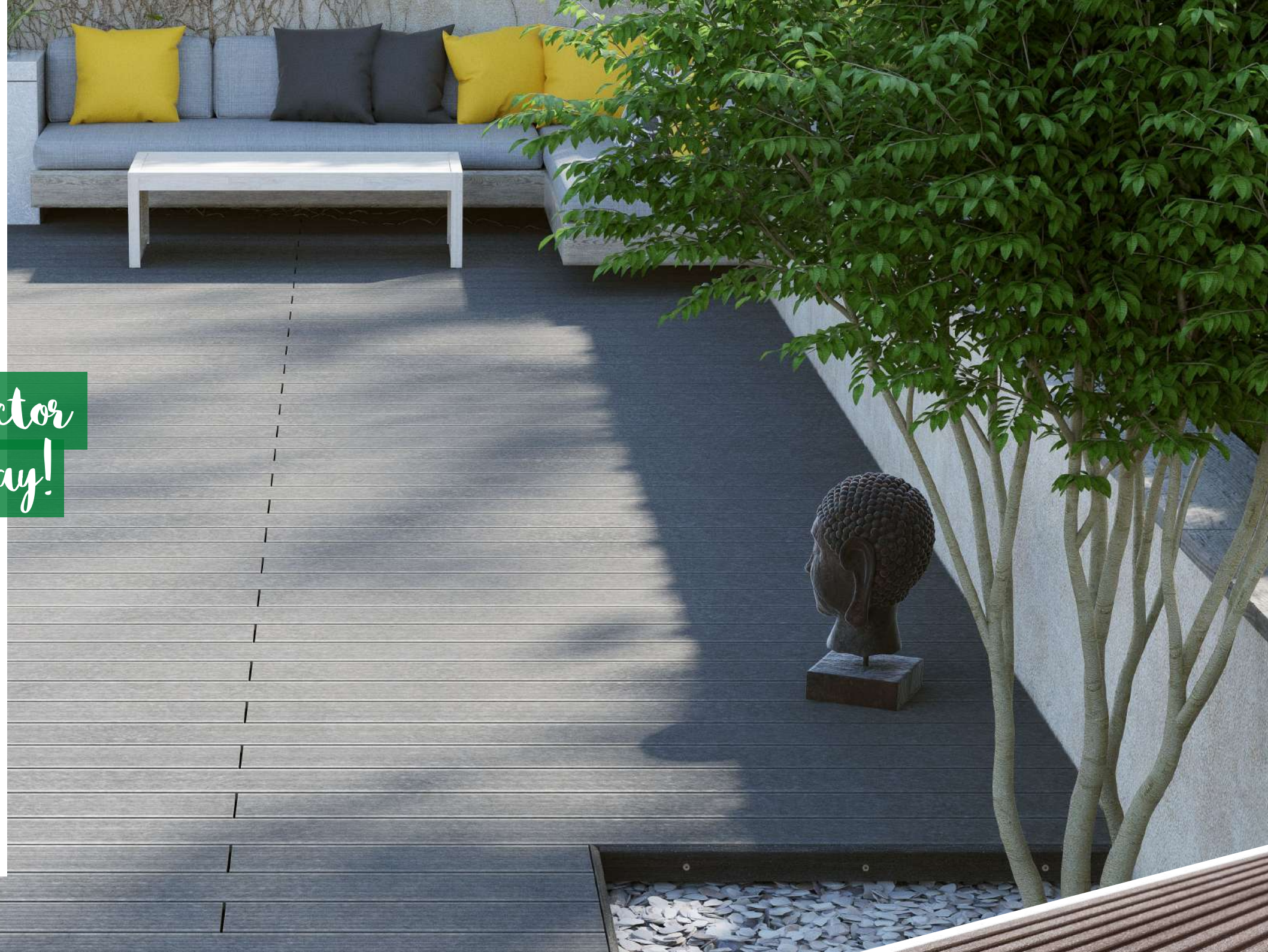

EasyDeck® Trend 16x163

16 mm thick deck board,
in two colours, 163 x 3000 or 4000 mm



The figure illustrates the EasyDeck® Trend product in Graphit

The wide deck board in grooved or finely corrugated design.

One board, plenty of options. Thanks to its modern characteristics, our wide Trend 16x163 deck board more than lives up to its name. It can be laid on both sides and is available in the covered terra and graphit colours. Finely corrugated on one side and grooved on the other. Irrespective of your decision, you will enjoy looking at the robust surface for a long time to come.

- // Surface: Finely corrugated or grooved
- // Can be laid on both sides
- // Gap width: 8 mm (± 0.5 mm)
- // Material: **GCC HOLZart**

Natural colour development

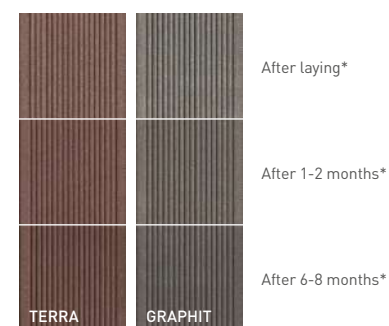

*The figures illustrate an example of the colours available for delivery and their natural colour development process



Resilient. Modern.
Extra strong!



EasyDeck® Trend 19x130

19 mm thick deck board,
in two colours, 130 x 3000 or 4000 mm



The figure illustrates the EasyDeck® Trend product in terra

The narrow deck board in grooved or finely corrugated design.

With a thickness of 19 mm, our Trend 19x130 board is a really tough cookie. The board has two different sides. One side boasts a fine corrugated design and the other side is grooved. Both sides can be laid in terra or graphit. By installing these colour resistant and anti-slip boards, you can upgrade your outdoor leisure time in a modern and safe manner.

- // Surface: Finely corrugated or grooved
- // Can be laid on both sides
- // Gap width: 8 mm (± 0.5 mm)
- // Material: **GCC HOLZart**

Natural colour development

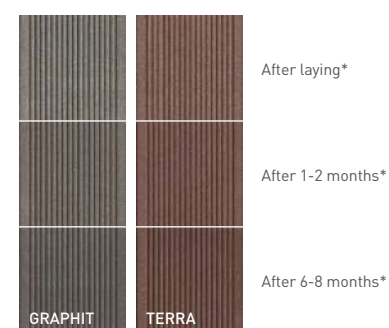

*The figures illustrate an example of the colours available for delivery and their natural colour development process



Extra slim.
Particularly expressive.



EasyDeck® Relief R24 16x145

16 mm thick deck board,
in two colours, 145 x 3000 or 4000 mm



The robust board with a special structure.

The RELIEF R24 deck board has an embossed, matt surface that is available in two elegant colour gradients. Measuring 16 x 145 mm and made of GCC HARZart, it brings modern design and functionality to your terrace. The structured surface ensures a harmonious look and a pleasant walking experience. Design your terrace with RELIEF R24 – naturally beautiful, robust and timeless.

// Surface: droved and matted
// Can be laid on one side
// Gap width: 5 mm (± 0.5 mm)
// Material: **GCC HARZart**

Natural colour development

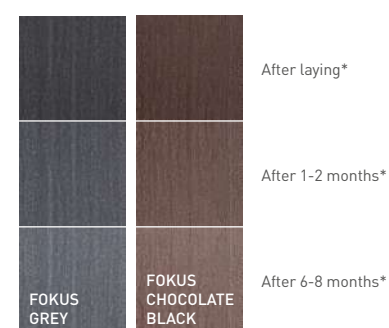

*The figures illustrate an example of the colours available for delivery and their natural colour development process



Classic appearance,
new advantages!



EasyDeck® Dolomit 19x145

19 mm thick deck board,
in two colours, 145 x 3000 or 4000 mm



The figure illustrates the EasyDeck® Dolomit® product in Fokus Grey

The classic deck board with natural colour gradient.

The Dolomit 19x145: Classic, premium and robust. The board with a corrugated, matt surface is available in either Fokus Brown or Fokus Grey. The utilised GCC HARZart material strengthens the board surface. It is sealed, easier to maintain and flame retardant. The structure and natural colour gradient turns your terrace into a pleasant oasis full of comfort.

// Surface: waved with colour gradient and matted
// Can be laid on one side
// Gap width: 5 mm (± 0.5 mm)
// Material: **GCC HARZart**

Natural colour development

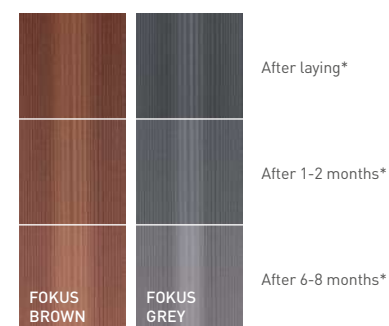

*The figures illustrate an example of the colours available for delivery and their natural colour development process



Brings light
into the darkness!



EasyDeck® Light System

LED spot set, IP67 lighting
Ø 34 mm (0.25 W) or Ø 60 mm (0.5 W)

The dimmable LED spots in a pleasant warm light tone.

The warm light emitted by the EasyDeck® spots immerses your deck in a wonderful atmosphere. Whether spending mild evenings together with friends or enjoying a romantic dinner on your deck: EasyDeck® light system charmingly emphasises these valuable moments. The LED lighting allows decks of all sizes to be upgraded with lights. Make use of your deck, no matter what the time of day!

- // 24 Volt DC IP67
- // Easy to assemble
- // Dimmable via remote control
- // Can be greatly expanded for radio control
- // Can be individually controlled
- // Scope of use: Private and commercial
- // Material: **Stainless steel spots**

Item overview



LED mini spot
Ø 34 mm (0.25 W)
10 lumen



2-way distributor



LED maxi spot
Ø 60 mm (0.50 W)
28 lumen



4-way distributor



Radio control
with remote control



1/3/6 m extension



Power pack 40 W



Ø 64 mm Maxi
Ø 37 mm Mini

Board overview

The EasyDeck® boards are just like nature - multifaceted and always have a surprise in store. The warm muted colours generate a unique feel-good factor and the versatile surface structures bring a liveliness and authentic detail to your deck. The natural and sustainable wood ingredients are resistant and strong when exposed to external influences, thus enhancing your outdoor area for a long time to come, until it can be provided with a new lease of life if it is returned to the production process for recycling.

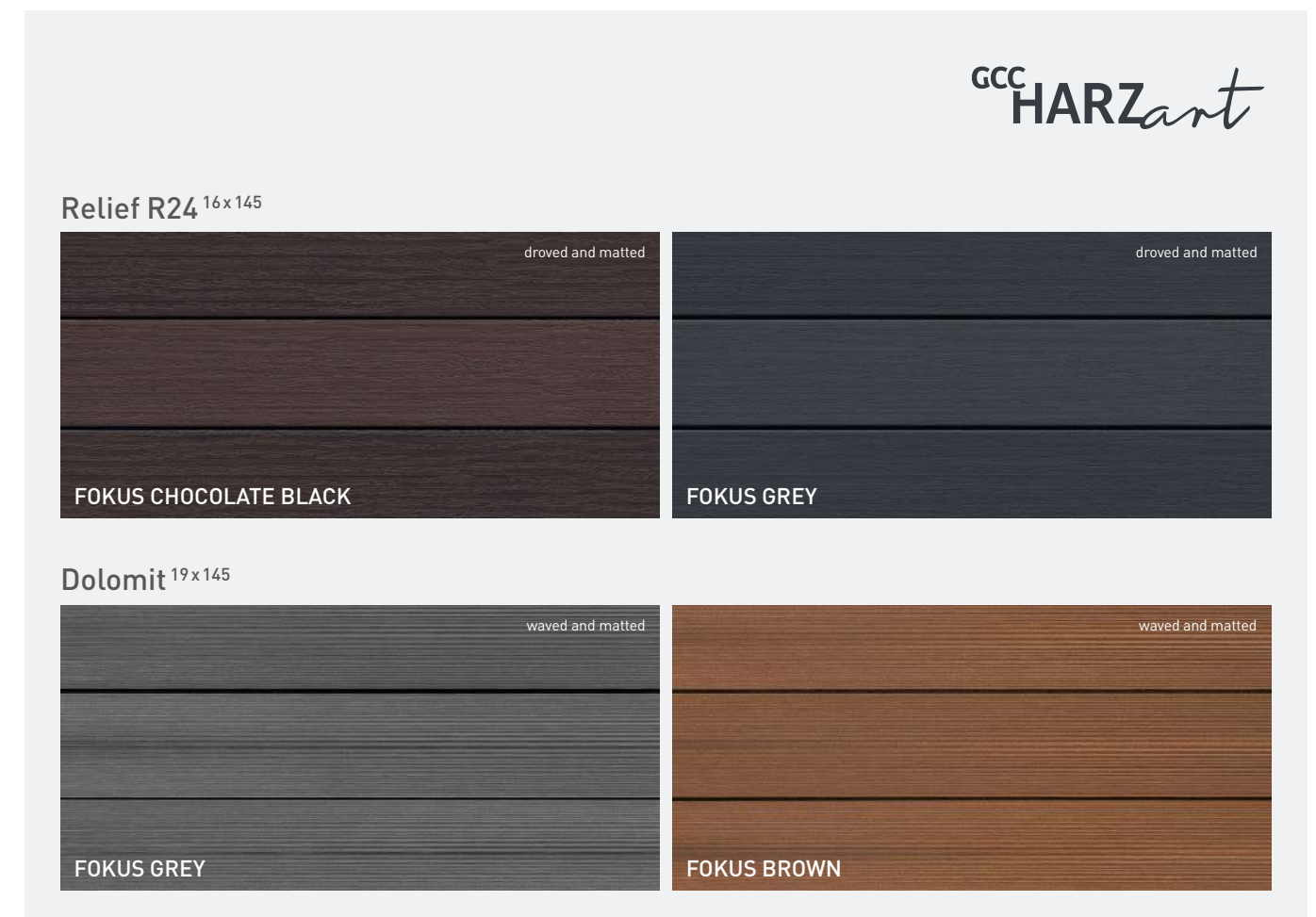
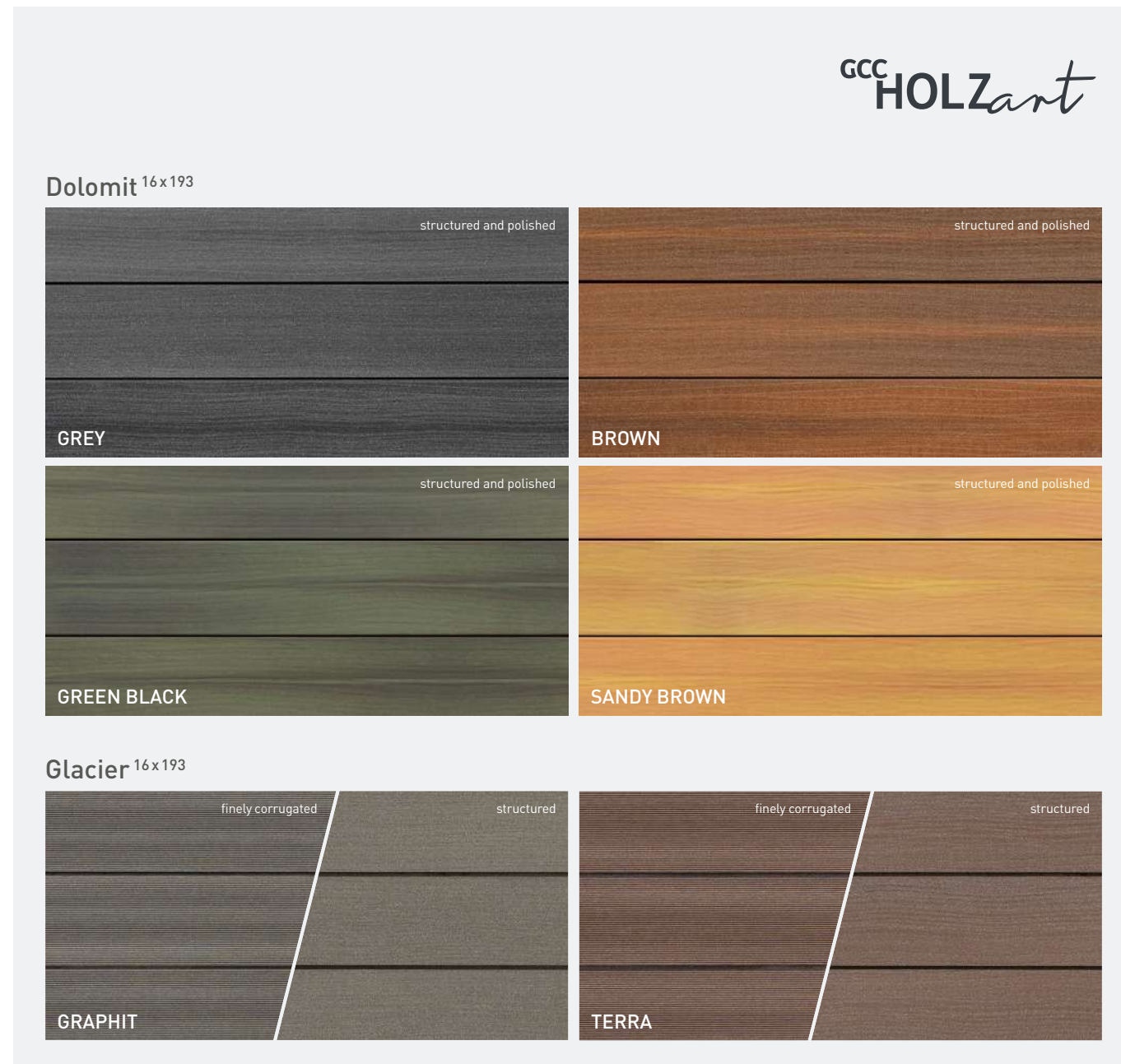

Simply decide, simply plan.

Transform your outdoors realm into a place of comfort with durable, easy-care, and unique products to match your needs and personal taste. The online planner will let your garden dreams come true. Plan the design of your outdoor area easily from home. This will show you what material you need and give you the plans and construction drawings to match from visualisation of your initial ideas to implementation of specific plans in just a few clicks.

Please use the following link to discover where you can purchase EasyDeck® as well as the accessories:
www.easydeck.de/en/dealer



Simply plan online:
planer.easydeck.de/en



Summary of articles

Articles for mounting with concrete kerbstones



Additional items for assembly with the ConStep system

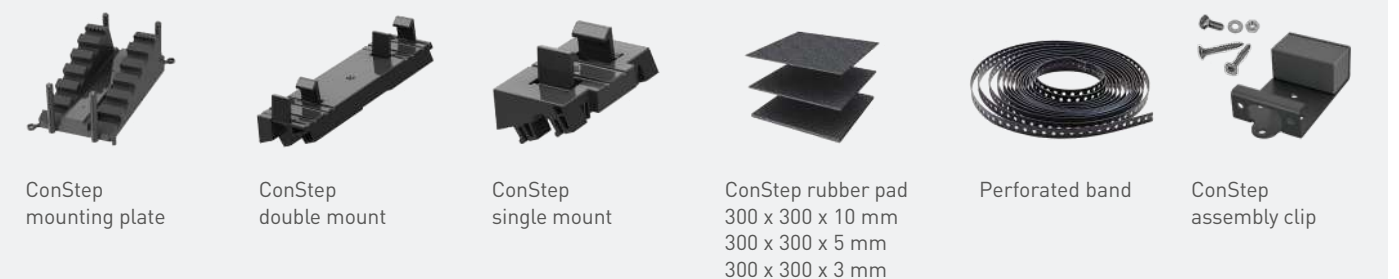

Rhombus profile as a closing strip 81 x 20,5 x 4200 mm

Rhombus profiles have a matted surface and differ from the deck board colours.

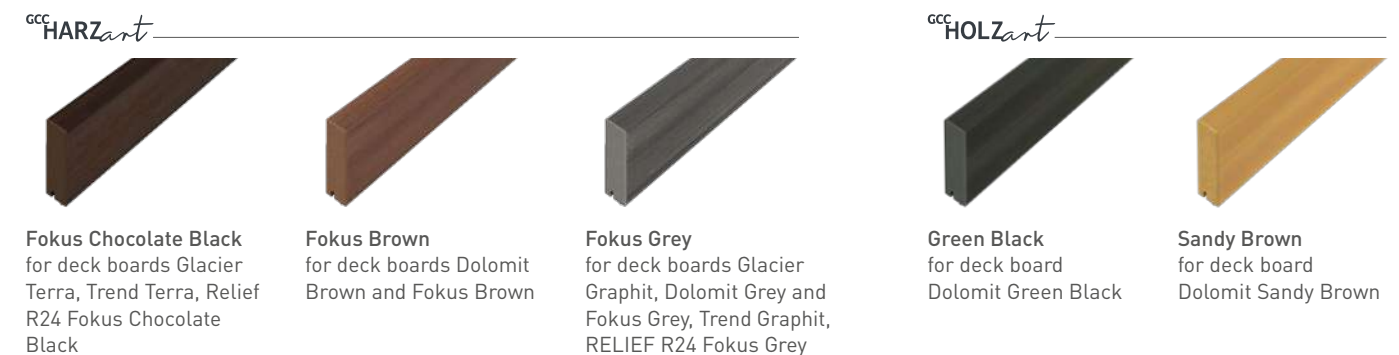

Easy processing of the material.

We have created an easy-care and resistant material. Products made of GCC HOLZart can be processed just like wood. Common woodworking tools can shape the material as desired by sawing, drilling, sanding, or planing. GCC HARZart is denser and harder due to its share of synthetic resins, causing greater tool wear. This is why we do not recommend full surface machining such as planing, brushing, or sanding.

We want you to enjoy your new terrace for a long time. Only use original EasyDeck® parts and observe our processing recommendations to ensure that our warranty does not become void. Coordination with the manufacturer must take place and respective approval must be obtained in the event of special structures that deviate from these processing recommendations or the online planner in order for any potential warranty claims to be accepted.

Setup could not be any easier

- // Avoid contact between the construction elements.
- // Ensure that the subsoil is firm and has a good load bearing capacity. For applications that require an official technical approval, a static sufficiently measured, bearing and walkable foundation as a support for EasyDeck® boards/subconstructions is also required.
- // When using metric screws, all of the holes should be pre-drilled so that the part that is to be fixed in place, is 2mm larger and the retaining drillhole is exactly 0.5 mm smaller than the diameter of the screw!
- // Observe the minimum clearances of the expansion joints so that the construction can expand without force if necessary and a sufficient amount of ventilation from underneath is ensured.
- // Cutting the longitudinal side of the boards may result in board offset.
- // Do not lash down or brace the deck during construction.
- // Rod-shaped components that are to be screwed onto a rigid substructure, always have the fixed point in the centre and floating outwards so that thermal expansion and an expansion due to an absorption of water can be compensated for.
- // Distance between the deck board and all fixed components: 20 mm
- // Do not fill cavity spaces between the level surface of the gravel and subconstruction elements.
- // Recommended minimum gradient of 2% in the longitudinal direction of the boards.
- // Maximum deck board protrusion over the last subconstruction is 50 mm
- // Production-related dimension tolerances regarding length, width and thickness are to be taken into account during assembly and the dimensions on the construction must be examined once again.
- // Choose the material versions for punched parts, such as standard steel or stainless steel for clips, to suit your structural conditions.
- // The boards are to be cut off at right angles and then to chamfer.
- // Wind load must be considered as a lifting load in the construction when designing a terrace.
- // **Predrill all of the holes before screwing it in place.**

Simply pay attention to the laying direction

Lay all of the boards in the same direction in order to obtain a homogeneous surface effect. This direction is shown by an arrow in the board groove or on a label on the board. Mix the boards prior to laying. This allows the slight differences in the colour of the boards to emphasise the natural appearance.



Mechanical characteristics

Three-point bending	Boards
Support clearance:	360 mm
Test speed:	20 mm/min
Breaking load:	3200 N*

*3200 N corresponds to = 320 kg/board with a maximal clearance of 400 mm from the substructure.

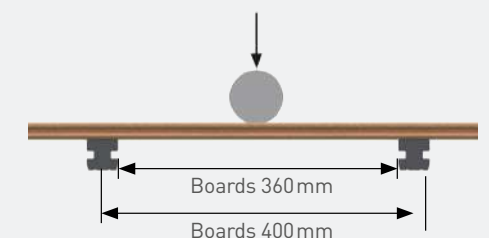

Production-related dimension tolerances

	Specification	Tolerance field	Dimension	Measurement point	Permitted dimension change after water absorption* (guaranteed values)	Remark
Profile length	3000/4000/5000 mm	- 0.0/+ 10.0 mm	Length	Maximum value	Board length 3000 mm ≤ 9.0 mm Board length 4000 mm ≤ 12.0 mm Board length 5000 mm ≤ 15.0 mm	Distance from other fixed components, min. 20 mm
Profile width	130/138/145/163/193/245 mm	- 2.0/+ 1.0 mm	Width max. 245 mm	Board, centre	≤ 1,2 mm	
Profile thickness	16/19/25 mm	- 1.0/+ 1.0 mm	Thickness max. 25 mm	Board, centre	≤ 0.5 mm	

*In the event of exposure to outdoor weathering and construction executed in accordance with the construction manual

Assembly on concrete edge stones

In accordance with good practice and constructive wood preservation principles, we recommend to lay the boards with a minimum gradient of 2% in the longitudinal direction. As a result, the water can flow away, waterlogging and building damage is prevented and water stains are minimised.

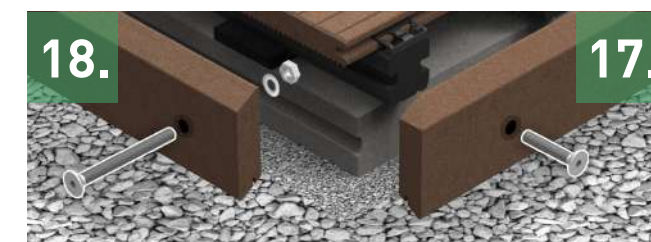
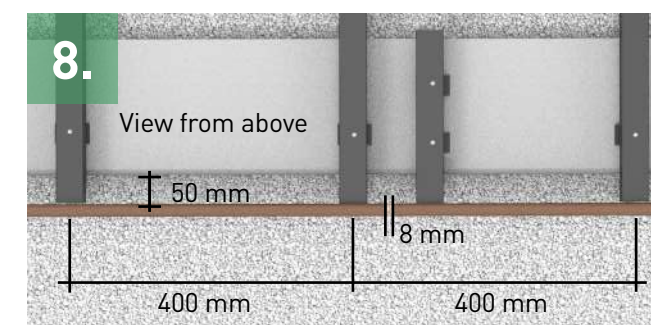
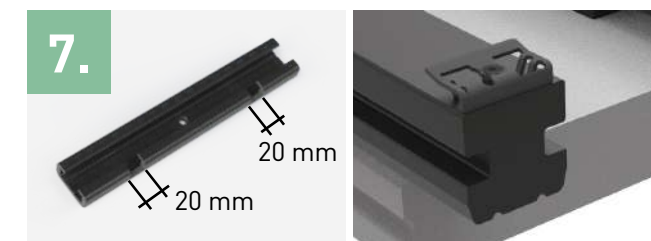
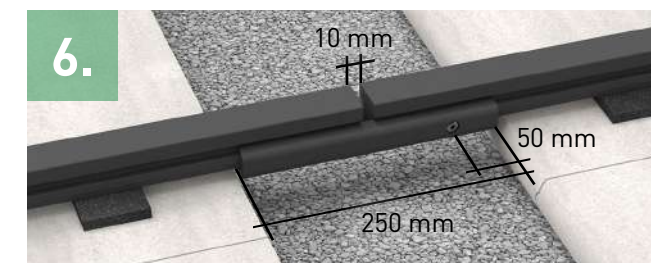
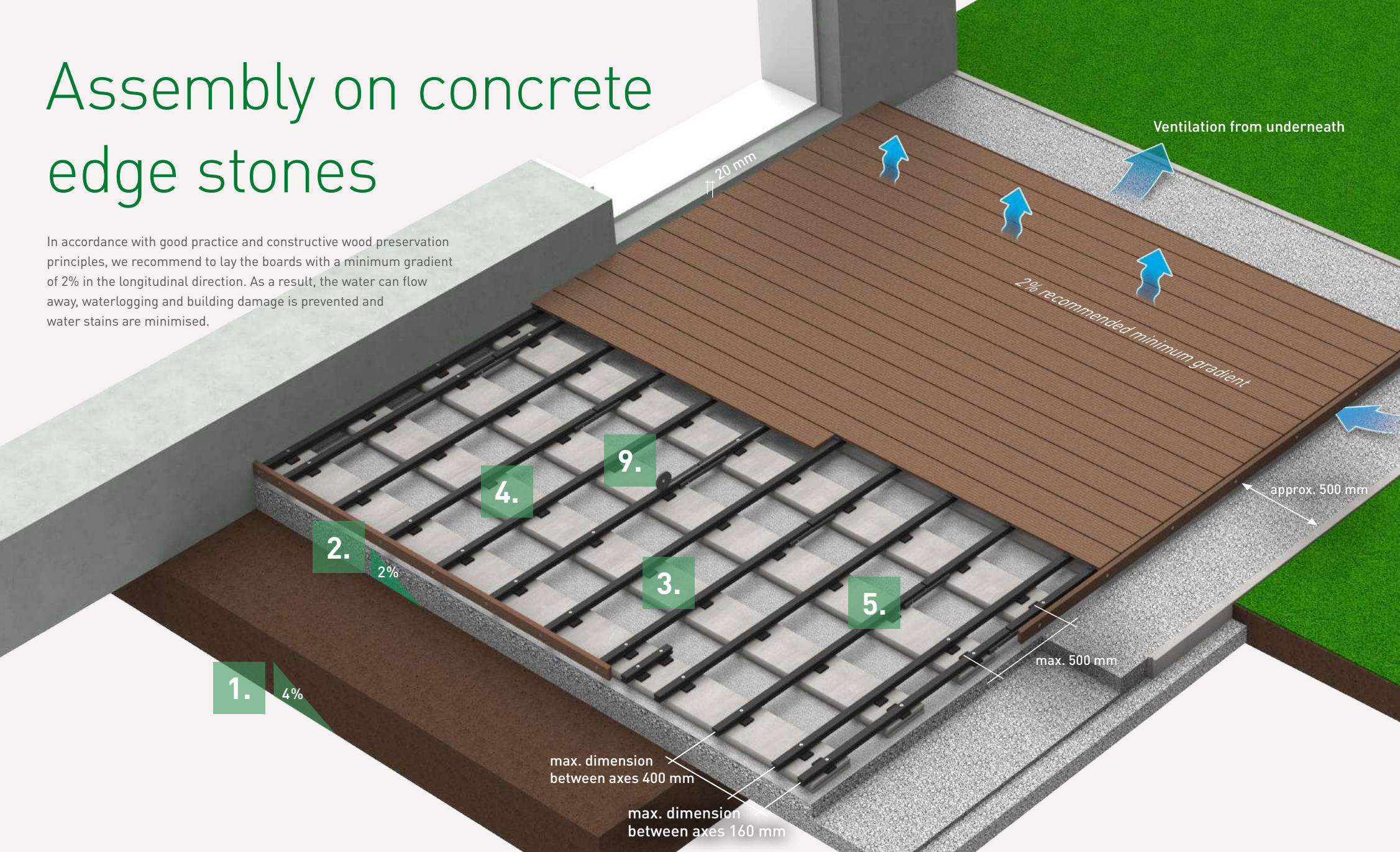

Preparation of the subsurface

1. Establish a soil formation with a gradient of 4%.
2. Whilst ensuring that it protrudes by 500mm around the circumference of the terrace, create a ballast bed (including drainage) with a 2% gradient. Apply fine grit to the ballast bed with a 2% gradient.

Assembly of the subconstruction

3. Lay the concrete edge stones (100x25x5cm) on a gradient gravel bed with a centre distance of 500mm.
4. Equally space the construction beams (40x40mm) transversely to the concrete edge stones (the groove is at the bottom), ensuring that there is a protrusion of 50mm on the end face (see detail 8). Position two beams at the beginning and two at the end (axial dimension: 160mm). Place 10mm rubber pads underneath the construction beam and compensate for any gradient differences with additional rubber pads. Screw the construction beams around the entire edge of the terrace and the beams that the retaining band is mounted on, to the concrete slab. When laying the terrace brick bond style, the construction beams need to be screwed to the concrete slabs that are positioned underneath the beginning and end of the board.

5. If the terrace should be more than 3m wide, the ends of the construction beam are always to be positioned offset and connected using the connecting clamp. The connecting clamp makes it possible to create terraces that are larger than 12x12m without the requirement for structural expansion joints.
6. Cut the connecting clamp to 250mm, drill a 12mm hole in the centre of the base of the connecting clamp and chamfer it for better water drainage. Connect the beam joints to each other and then screw tightly on one side (clearance of the joints: 10mm).
7. Saw the connecting clamp to a width of 20mm and a depth of 10mm at the outer construction beam so that the rhombus profile can be used as a closing strip in the area of the screwed connection. The butt joint of the rhombus profile accommodate the butt joints of the subconstruction.
8. Mount an additional piece of construction beam piece (length 320mm) for butt joints of the rhombus profiles in the direction of the boards. The butt joint of the rhombus profiles will accommodate the butt joint of the boards with the boards laid in brick bond style. Screws are placed in the double mount construction beams.
9. Fix the retaining band to a construction beam that is located in the centre underneath the board. When using the Distanz Fix when laying brick bond style, the retaining band has to be fixed to each of the construction beams.

Assembly of the boards with clip

10. Chamfer the cut edges of the boards.
11. Place an edge clip at the beginning of the face of the construction beam so that it is flush with the beam, pre-drill to a depth of 3mm and loosely fix in place using a screw (do not tighten yet).
12. Push the first board onto the positioned edge clip. Use the clip for the following boards, pre-drill to a depth of 3mm and loosely connect it to the construction beam using the enclosed screws. Now push the next board against it until the clip is positioned against the groove. Tighten the clip applying the average torque after approx. 5 rows of boards have been laid. Repeat this until the last board but one has been laid.
13. After laying the last board but one, determine the width that is required for the last board and saw the construction beam to the required length so that it is flush. The construction beam has to protrude over the edge of the design beam by 10mm so that the edge clip can be positioned as a final mounting.
14. Position the final board and fix the edge clip in place. Pre-drill a hole for the screw and screw in place applying an average torque.
15. Cut the boards to length at a right-angle at the face edge, ensuring that there is a protrusion on 15mm. Maximum board protrusion: 50mm. Chamfer the cut edges.

Mounting the rhombus profiles as closing strips

16. Leave a minimum clearance of 15mm between the rhombus profile and the surface of the ground.
17. Screw the rhombus profiles maximum 60mm from the ends and maximum 400mm from each other and pre-drill true to the principles. When laying parallel to the boards, screw on using M8x40mm screws so that they are flush with the end edge of the construction beam. Act in accordance with Detail 8 as regards butt joints.
18. When mounting at the face towards the boards, screw on using M8x80mm fastening screws and use the corresponding nut as a spacer and in order to fix in place.

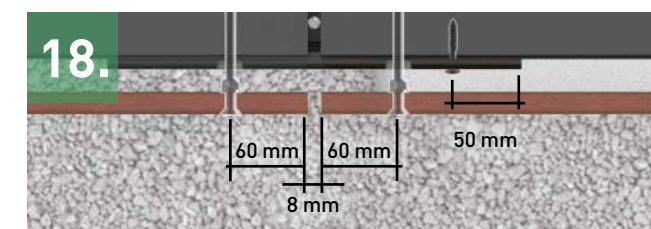

Assembly with ConStep system

Our sophisticated ConStep system is the best subconstruction for your EasyDeck® terrace. The system components impress with their lightness, variable installation heights and ease in terms of laying. Single and double mounts are clicked into the ConStep mounting plate and form the base of the construction beams which will be applied on top.

Easily implemented variable installation heights

Our patented click system ConStep allows construction heights of between 98–143 mm (in steps) to be easily implemented.

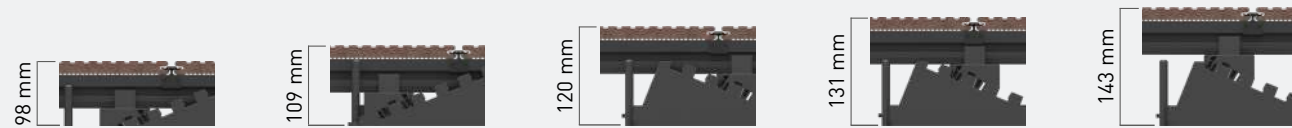

Preparation of the subsurface

1. Establish a soil formation with a gradient of 4%.
2. Whilst ensuring that it protrudes by 500 mm around the circumference of the terrace, create a ballast bed (including drainage) with a 2% gradient. Apply fine grit to the ballast bed with a gradient of 2%.

Assembly of the ConStep plates

3. In all of the ConStep mounting plate, click in the single and double mounts to the same height and centrally bond into place with a piece of retaining tape.
4. Position the ConStep mounting plate with double mount at a distance of 80 mm to the house wall and a maximum alignment of 500 mm to the next ConStep mounting plate with double mount.
5. Position the ConStep mounting plate with single mount with max. 400 mm dimension between axes in the next row.
6. Conclude the end of the deck using a further ConStep double mount. Click the subconstruction into place.
7. Minimise protrusions. In order to do so, turn the ConStep mounting plate where necessary.
8. Using the ConStep assembly clip, reinforce the entire subconstruction with perforated band in a crosswise manner.

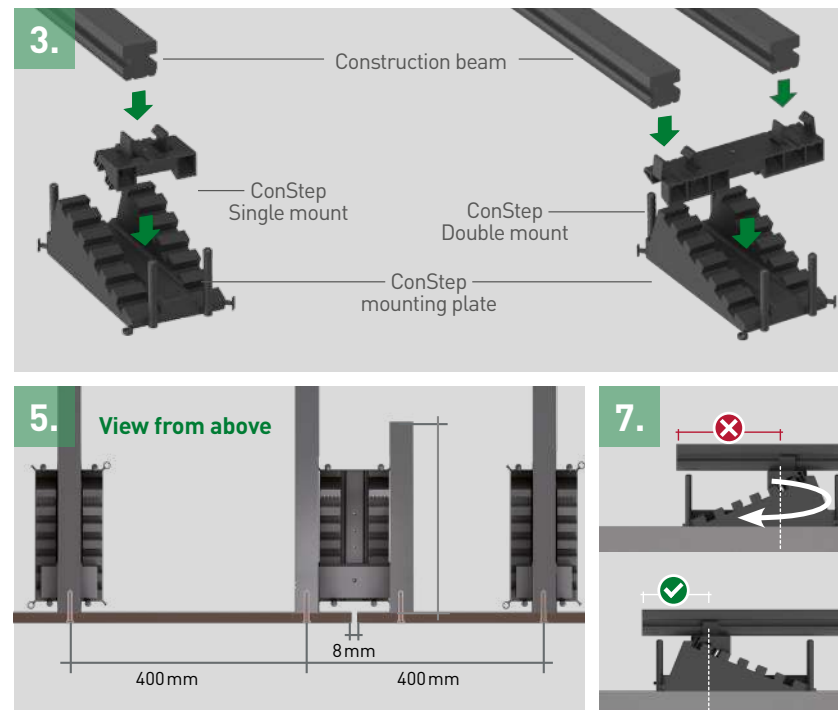

Continue as described under mounting of the subconstruction concrete edge stone items 4 to 9 on page 28.

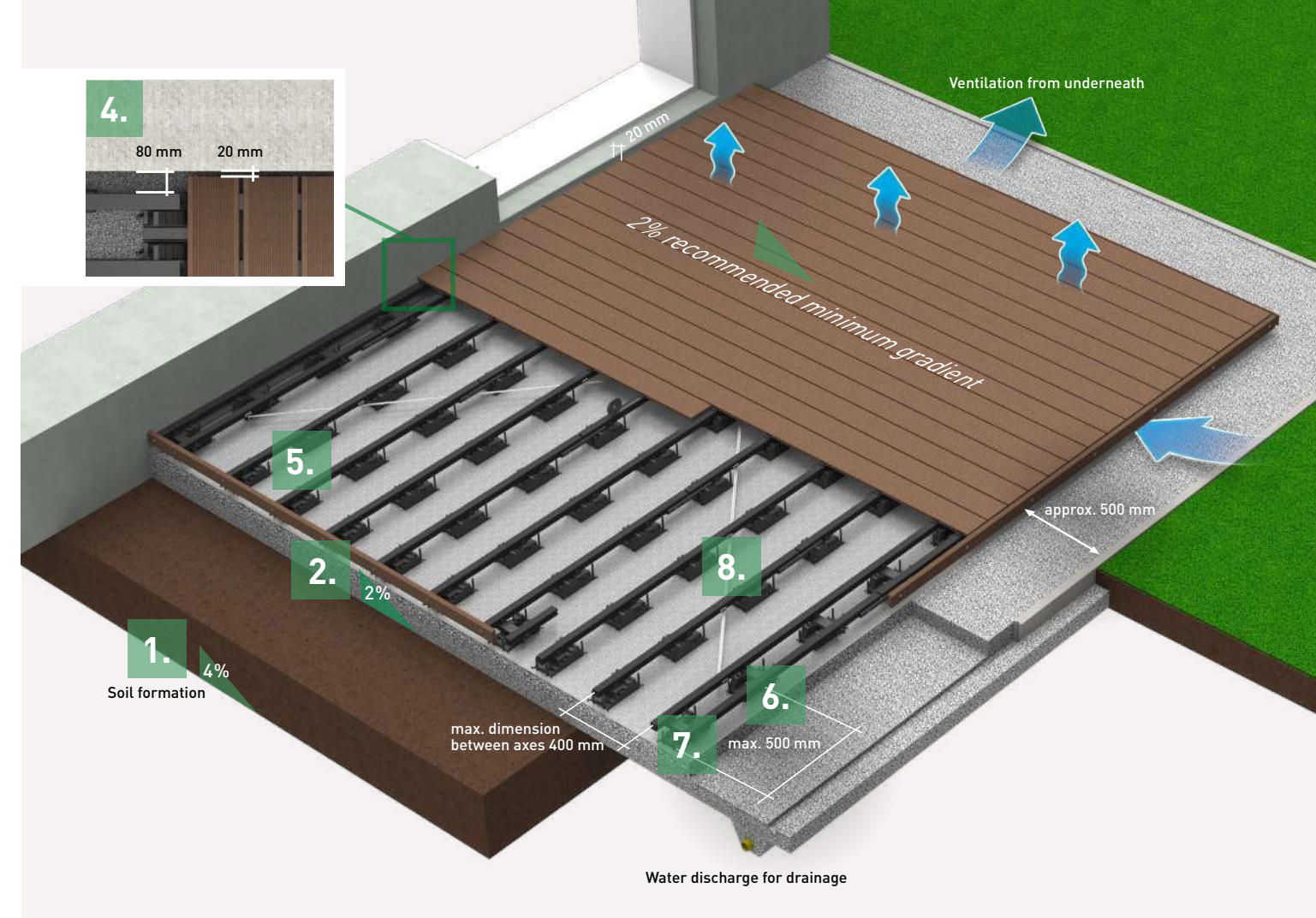

Assembly of the board with locking clamp

9. Saw into the construction beam from the side from which the boards are to be laid. This must be performed 12 mm from the edge, to a depth of 5 mm and to a width of 2 mm. Position the edge clamp in this groove and, using pliers, fix together with the construction beam and push the board into the edge clamp.
10. Place the locking clamp onto the construction beam, fix into place using pliers and push into the deck board groove. Using the supplied screw, engage the lock lips into every 3rd deck board row on the construction beam.
11. After the penultimate board, determine the required width for the last deck board and saw the construction beam to length so that it is flush. In doing so, please note that the construction beam must protrude by 12 mm from the last board (for fixation of the edge clamp).

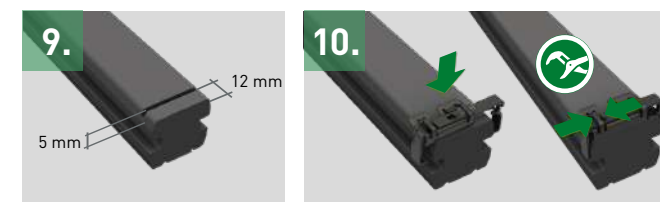

Mounting the closing strips: please refer to items 16 to 18 when assembling with concrete kerbstones

Installation in a brick bond with double subconstruction beam

Clearance between the boards at the end edge: min. 8 mm. Use the Distanz Fix component for an ideal gap appearance. At the joint of two boards, use a construction beam at the start and end of the board respectively. Do not hit on a construction beam.

Assembly with the example of ConStep double mount

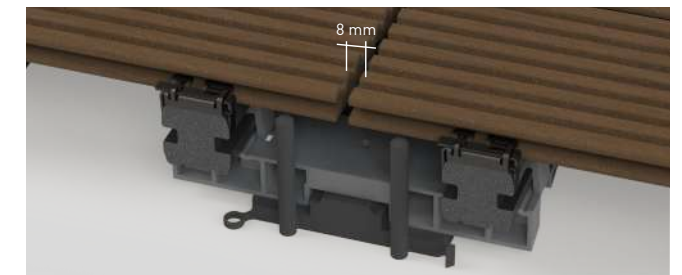

Installation using the example of concrete kerbstone

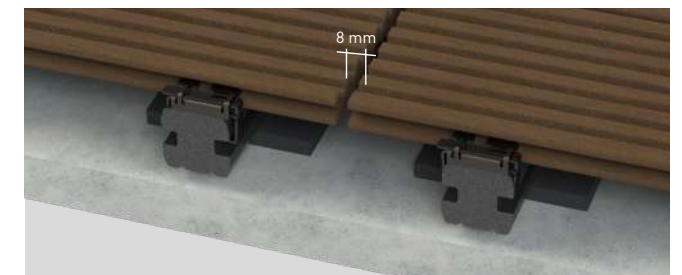

Simple terrace maintenance

Your EasyDeck® terrace is not only a place where you feel comfortable, it is also easy to maintain. Stains do not come from the material itself, but from environmental influences such as dust, pollen or water stains - often at the transition between roofing and open space. Even stains caused by normal use usually remain superficial. They can be easily removed with water and a scrubbing brush. Sun and rain often cause residues to fade. Additional cleaning agents are rarely necessary - this makes the maintenance particularly environmentally friendly.

When laying the boards, we recommend a slope of at least 2% so that water can drain away better and fewer sediment deposits form. For a well-kept appearance, a basic clean is sufficient twice a year, or more often if necessary - ideally at temperatures above 15°C.

You will find detailed information on how to clean and care for your terrace in the terrace pass and on our website.



Please proceed as follows when cleaning:

1. Brush away any dry, loose dirt from the terrace deck.
2. Sufficiently water the entire terrace deck and keep moist for at least 15 minutes.
3. Clean the decking with water and a standard scrubbing brush or root brush.
4. Thoroughly rinse the decking with clean tap water. Wipe with a rubber squeegee and allow to dry.

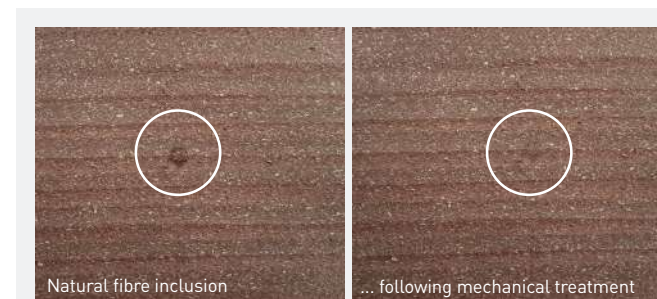

Simply real natural fibres

Your decking can look natural - small inclusions of bast and natural fibres are part of that. These can rise to the surface over time if the decking boards are exposed to the weather and moisture. No need to worry: over time, these particles will almost disappear by themselves through normal use of the decking. If you still want to remove them, you can easily do so mechanically without damaging the material. Your decking will remain robust and durable. So: enjoy the great outdoors on your decking as it is!

Powerful cleaning

Many stains on your decking made of GCC HOLZart and GCC HARZart will disappear by themselves with sun and rain. For more stubborn stains, our liquid cleaner **GCC Pure Wash** will help - it is phosphate-free and completely biodegradable. Simply mix GCC Pure Wash (1 part) with water (2 parts), apply to the decking and scrub with a brush. A pressure sprayer will make it easier to apply the solution evenly. Then rinse with plenty of clean water and remove any standing water.

For stubborn stains on planks made of GCC HOLZart, our scouring powder and GCC scrubbing brush (corundum scrubber) can be used in addition to GCC Pure Wash.

NEW!



Important note for boards of GCC HARZart!

Do not use scouring powder or GCC/corundum scrubbers on GCC HARZart decking boards with an embossed or matted surface!

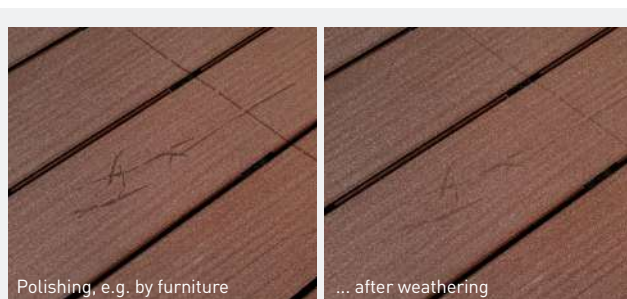

Simply wait

Your terrace is full of life and that's a good thing! Don't worry about traces of use or instances of "polishing" that are caused by the furniture. Weathering usually causes traces of use on the deck board surface to disappear over time. So sit back and relax! However, if you do want to do something about it, just clean your terrace regularly. This ensures that fewer visible traces of use occur.

Construction Timber Range

The EasyDeck® construction timber range is made for all kinds of ideas and captivates with its great flexibility. Numerous outdoor designs can be created using the enclosed rhombus profile and the construction plank.

Rhombus profile

The rhombus profile can be used both as a stylish cladding element and as a closing strip to terrace decks and it is available in nine colours. The colours of the rhombus profile is assigned to a colour spectrum ensuring harmony with the chosen terrace boards. You can determine which profile best matches your terrace deck by going to page 25.

Construction plank

The construction plank in the dimensions 40 x 112 x 3600 mm is your key to infinite creativity. The construction planks are available in a total of nine colours so that they serve a customised implementation of garden elements and furniture. Everything is possible with construction timber, whether a sandpit, a raised gardening bed or a bench.



The large variety of colours in the construction timber range

Rhombus profile



Construction plank





Infinite
creativity!



EasyDeck® Construction plank

40x112x3600mm, in nine colours



The construction planks that match creative ideas

Made for free thinkers: the structural piles as a part of the construction timber range! Classical or completely customised designs can be implemented in combination with the rhombus profiles. Innumerable creative ideas can find their space in your outdoor grounds on the basis of our innovative composition of materials. With a variety of nine colours, the construction planks are a perfect match to the look of your terrace and leave nothing to be desired.

- // Form: rectangular (GCC HARZart), rectangular with bevelled edges (GCC HOLZart)
- // Available in nine colours
- // Material (Titan, Umbra, Terra, Graphit, Brown, Grey): **GCC HOLZart**
- // Material (Ecrú, Jade, Platin): **GCC HARZart**

Variety of colours

The construction plank is available in a total of nine colours.

You will find the entire variety of colours that the construction timber is available in on page 33.





A profile with charm!



EasyDeck® Rhombus profile

20.5x81 x 4200 mm,
in nine colours, min. joint clearance 5 mm



The solid rhombus profile with its attractive colour gradient for stylish cladding

You can use the rhombus profile as a tasteful wooden cladding or as closing strips for your new terrace. The solid profiles in nine colours captivate with an attractive colour gradient and skilfully insert themselves in all environments. **Fastening options are available exposed with screws or concealed with clamps.** The rhombus profiles can also be mounted within a multiple field system with a max. axial dimension of 80 cm or in a single field system with max. 60 cm.

- // Surface: with a colour gradient, matted, with vascular rays on one side
- // Visible screw fastening or concealed clamps
- // min. joint clearance: 5 mm
- // Material (Green Black, Sandy Brown): **GCC HOLZart**
- // Material (Fokus Chocolate Black, Fokus Brown, Fokus Grey, Ecrú, Jade, Platin, Umbra): **GCC HARZart**

Fastening



Stainless steel clamp, blackened stainless steel

Variety of colours

The rhombus profile is available in a total of nine colours. You will find the entire variety of colours that the construction timber is available on page 33.





A fence in no time at all!



EasyDeck® Bar fence

Blickfang

- height and width individually adjustable
- can be erected at all angles
- slope-adapted installation possible
- 25 year guarantee against rotting in the ground

The figure illustrates the EasyDeck® bar fence product in graphit

The classic fence equipped with solid bars

With the EasyDeck® bar fence, you can upgrade your garden with a decorative boundary manufactured from innovative material. Adapt it to your garden requirements: Thanks to flexible connecting elements that can be utilised, the solid bars can be installed in various ways and at different heights. Matching doors and gates are also available on top as an optional design! The fixed anchoring of the post with the foundation means that the bar fence is equipped for all types of weather. Not only that: You don't need to worry about the posts rotting in the ground for 25 years – that's our guarantee!

- // Form: Square, curved
- // Dimensions: 40x112mm
- // Length bars: 178.6cm or 360cm**
- // Pre-assembly also available for order
- // Matching doors and gates available
- // Material: **GCC HOLZart**

**for structures which are adapted to the slope

Natural colour development

		After laying*
		After 1-2 months*
		After 6-8 months*



*The figures illustrate an example of the colours available for delivery and their natural colour development process



A top quality boundary!

ALSO AVAILABLE IN A SET WITH A STAINLESS STEEL BAR!



EasyDeck®
Privacy screen fence
 “Blickfang” with GCC bar

- height and width individually adjustable
- can be erected at all angles
- slope-adapted installation possible
- 25 year guarantee against rotting in the ground
- easier to maintain

The figure illustrates the „Blickfang” privacy screen fence with GCC bar in jade

The strong privacy screen with corrugated panels

Successfully enjoy a degree of privacy and emphasize features with the “Blickfang” privacy screen fence. Its unusual appearance with marbled, corrugated panels immediately catches the eye. The material is colour-resistant and dirt-resistant. The panels almost clean themselves thanks to the vertical position and weathering. Doors and gates can also be suitably integrated and gradients as well as all types of angles can be tackled without any problems whatsoever. Our posts are also extremely durable – we provide you with a 25-year guarantee against rotting in the ground. In short: The perfect boundary option for your garden!

- // Surface: Marbled and corrugated
- // Dimensions: 35x270mm and thickness: 6 mm
- // Length panels: 160.2cm or 210 cm**
- // Pre-assembly also available for order
- // Matching doors and gates available
- // Material panels: **GCC HARZart**
- // Post and transom material: **GCC HOLZart**

**for structures which are adapted to the slope

Natural colour development

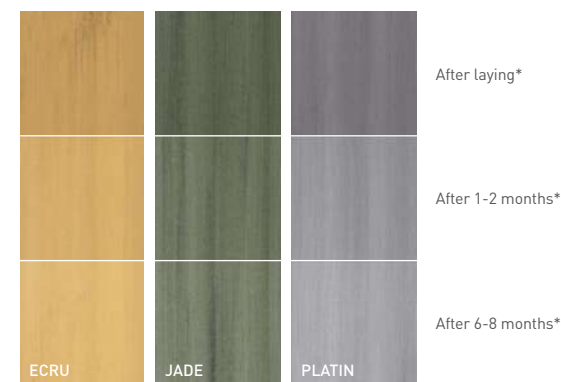

*The figures illustrate an example of the colours available for delivery and their natural colour development process

Simply thinking outside the box. Simply variable.

This EasyDeck® construction manual is the basis for all versions of fence assembly. Only use original EasyDeck® articles and simply follow our processing recommendations to ensure that our warranty does not become void.

EasyDeck® fences can be adapted to individual requirements via the online planner. In order to ensure that assembly is easy, we can pre-assemble all elements on your behalf if requested. This means that you do not need to perform the time-consuming pre-drilling of required holes or adaptations of diagonal section and you can simply start with the assembly!

Simply plan your individual fence online at: planer.easydeck.de/blickfang/en

PRE-ASSEMBLY ALSO AVAILABLE FOR ORDER

Setup could not be any easier

- // When mounting by screwing onto the base plate, only use posts with a length of 2.20m. The maximum construction height of 2 m (upper edge of the floor to the upper edge of the post) may not be exceeded. Caution: Higher structures do not correspond with the static requirements.
- // Holes are to be pre-drilled 0.5mm smaller than the screw diameter. In order to ensure a full seating, sink the drillholes for bar connectors. Ensure that the clearance from the edge is at least 10mm.
- // When mounting the posts and the bar, ensure that you keep to a clearance of 12mm so that the construction is able to expand without pressure if necessary.
- // The full engagement of the bar connectors when performing the final assembly ensures complete stability.
- // Assembly and production-related tolerances regarding length, width and thickness are to be taken into account during assembly and the dimensions on the construction must be examined once again.

Installation which is adapted to the slope

Gradients in the terrain? Not a problem for the EasyDeck® privacy screen or the EasyDeck® bar fence. The EasyDeck® system sizes can be installed on inclines measuring up to 3%. When dealing with gradients below 10%, use the special lengths or the **fence field set with stainless steel bar**. Greater differences in height in the terrain can be individually adapted by **diagonal cuts to the bar and on the element**.



Angle structure

The oval EasyDeck® post shape and the innovative bar connector allow the bar fence and privacy screen to be positioned with a free choice of angle.



Anchoring options

25 year guarantee against rotting in the ground

EasyDeck® posts are durable, even when installed in the ground. **We offer you a 25 year guarantee against rotting!** You can choose between encasing the posts in concrete or on base plates.

Simply encase the posts into concrete

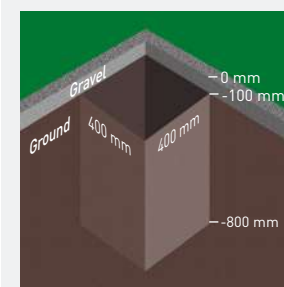

Dig all of the foundation holes (400 x 400 x 800 mm).

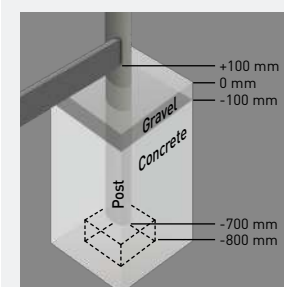

Fill the foundation hole with concrete to a depth of 100 mm. Position the frame in the foundation hole at a depth of -700 mm. Precisely apply the lower edge of the post with the aid of a small brick. Apply concrete into the foundation hole to a level of -100 mm. All posts must be vertically aligned.

Simply assemble the posts on the base plate

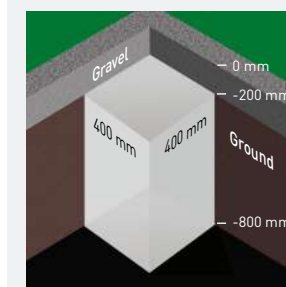

A separate, suitable foundation is required. For this purpose, dig all of the foundation holes (400 x 400 x 800 mm) and fill with concrete to a height of between -800 mm and -200 mm. Allow to fully harden. Alternatively, a suitable anchoring system can be installed on-site.

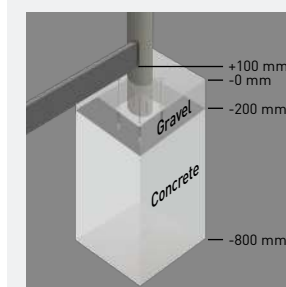

Pre-drill the holes on the post for the base plate (75 x 850 mm). Screw the base plate to the oval post (3 M8 x 80). Fasten the base plate complete with post to the foundation using a suitable anchoring system. All posts must be vertically aligned.

Assembly process of the „Blickfang“ privacy screen fence

134 mm from the upper edge of the post to the lower edge of the bar connector

1754 mm between the lower edge of the top bar connector and the lower edge of the lower bar connector

12 mm from the lower edge of the bar connector to the lower edge of the bar

Positional fixing with auxiliary objects. (not included in the scope of delivery)

10 mm open width between the post and panel

10 mm

Possible fastening points for panel holders

Ø 2,5 mm (2x)

Ø 3x20 mm (2x)

For diagonal field only!

View from underneath

View from underneath

Possible fastening points for panel holders

Ensure expansion without force!

34 mm from the upper edge of the post to the upper edge of the bar

1810 mm open width between posts

1642 mm open width between the lower edge of the upper bar and the upper edge of the lower bar

100 mm open width between the lower edge of the bar and the upper edge of the ground

The frame construction

1. Screw the "Post" connecting part of a bar connector to the post. On the frontal sides of the bar, centrally position, mark, and screw on the "Bar" connecting part. Using a 5.5 mm drill, pre-drill and countersink the holes to 35 mm.
2. Fully engage both bars on the post.
3. Position the pre-assembled frame and vertically fasten it in the foundation (encased in concrete or screwed). Prepare all further frames. In order to do so, screw the bar connector to the next post and bar according to the instructions (see item 1). Attach the post in the foundation vertically and engage the upper and lower bars.

Simple panel assembly with the GCC bar

4. Insert the panel holder into the holding plate; turn it beyond the latching moment and centrally position the panel holder in the holding plate.
- 4a. For the diagonal field, position the panel holder with the hook at the lower stop of the holding plate.
5. Push the lower panel holder on the first panel centred at the first bead (left or right). Place this panel between the bars starting 10 mm from the post, align the holding plate on the bar chamfer, determine the bore in the lower bar, and mark it precisely. Pre-drill with 2.5 mm drill and fasten with 3 x 20 mm screws.
- 5a. For the diagonal field, start panel setup from below. Always let the panel holder hit the lower stop of the holding plate as a fixed point in order to ensure even expansion of the panels. Align the holding plate on the bar, pre-drill and screw it on.
6. Push on the upper panel holder with the holding plate centred on the highest bead of the first panel and fasten it according to the instructions (see item 5).
7. In the following panels, push on the lower panel holders with the holding plate centred on the highest bead and connect the panel with the previous one by pushing it in.
8. Fasten the lower panel holders according to the instructions (see item 5). Ensure that the panels can expand without force. Let the last panel end 10 mm from the post.
9. After attaching all lower panel holders, push on the upper panel holders with the holding plates and fasten them according to the instructions (see item 5). Also ensure expansion of the panels without force.
10. Install the next fence field in the same manner.

Please use our fence configurator that is available online at planer.easydeck.de/blickfang/en for individual structures, e.g. inclined adaptation to the slope.

Article overview for the assembly of the „Blickfang“ privacy screen fence

25 year guarantee against rotting in the ground

Post
 Dimensions: 60 x 90 mm
 Colours: Terra and Graphit
 Length: 220 cm, 270 cm (available in a 360 cm version for structures which are adapted to the slope)

Panel
 Dimensions: 35 x 270 mm
 Colours: Jade, Ecru and Platin
 Length: 160.2 cm (available in a 210 cm version for structures which are adapted to the slope)
 Thickness: 6 mm
 Requirement: 7 units per field

Panel holder
 Requirement: 14 panel holders per field (with 7 panels), incl. holding plate and screws
 Material: Stainless steel

Bar
 Dimensions: 40 x 112 mm
 Colours: Terra and Graphit
 Length: 178.6 cm (available in a 360 cm version for structures which are adapted to the slope)

Bar connector, two-part post/bar
 Requirement: 2 parts per bar
 Material: Blackened stainless steel incl. 4 screws (M6 x 30 mm) per connector

Base plate – post
 Dimensions: 120 x 140 mm
 Requirement: 1 unit per post
 Material: Steel galvanised
 Thickness: 8 mm incl. 3 fastening screws (M8 x 80 mm) per plate

Door and gate
 Dimensions: 102 x 185 cm (Frame: 112 x 270 cm)
 Colours: Frame: Terra and Graphit
 Panels: Jade, Ecru and Platin incl. fittings, pre-aligned for profile cylinders.
 Production available on request

Attention: Connect the frame to the post in a force-locking manner using 5 M8 x 80 fastening screws per side, connect and then encase into concrete together.

Bar fence assembly procedure

1. Screw the "Post" connecting part to the post. Pay attention to the "TOP" labelling. Using a 5.5 mm drill, pre-drill and countersink the holes to 35 mm.
2. Screw the "Post" connecting part to the post at equally spaced intervals. Please note that the bottom fence bar has a gap measuring at least 100 cm to the ground.
3. Centrally position, mark, countersink and screw the "Bar" connecting part to the frontal sides of the bar.
4. Insert the bottom and top bars but do not fully engage the top bar.
5. Position the pre-assembled frame and **vertically** concrete/ screw into the foundation. Please see Anchoring options. Once the concrete has set or after the screwing process has been completed, remove the top bar, insert all of the missing bars from beneath and fully engage.

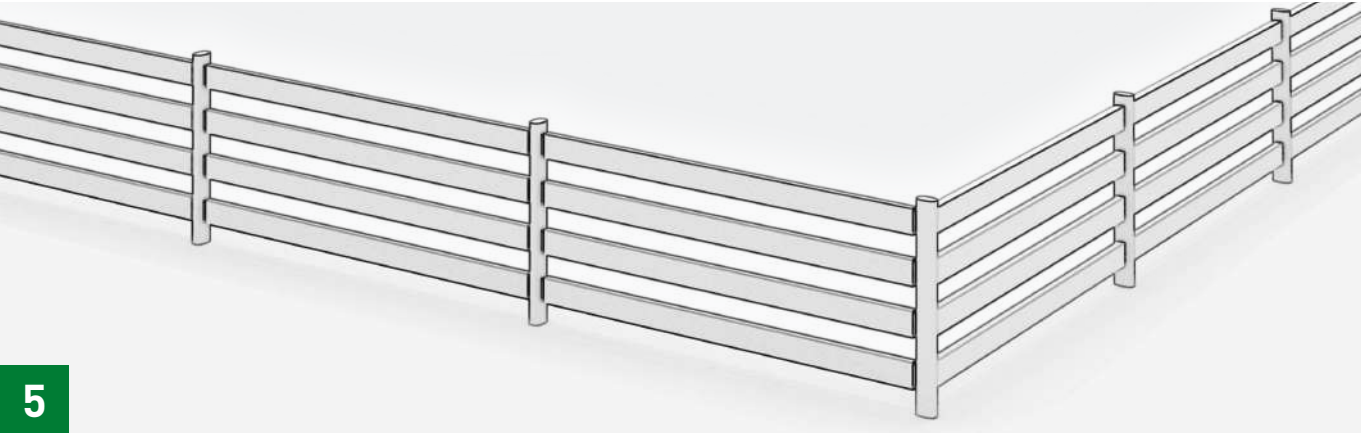
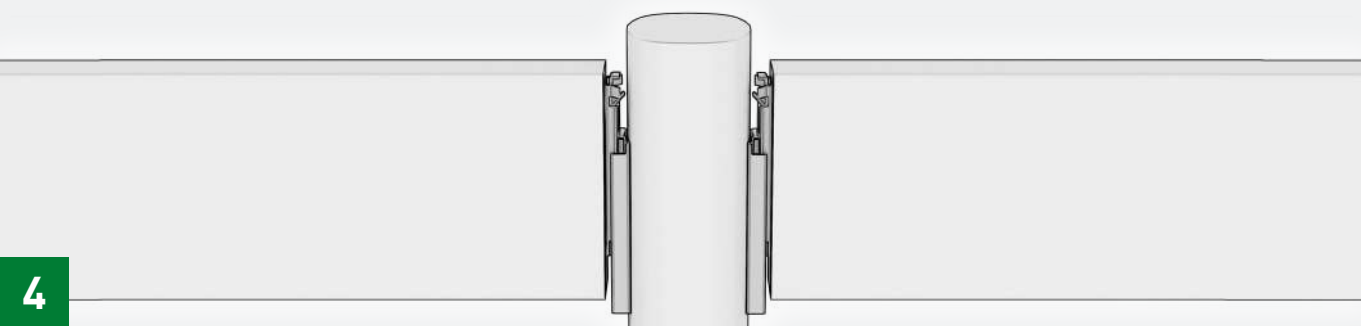
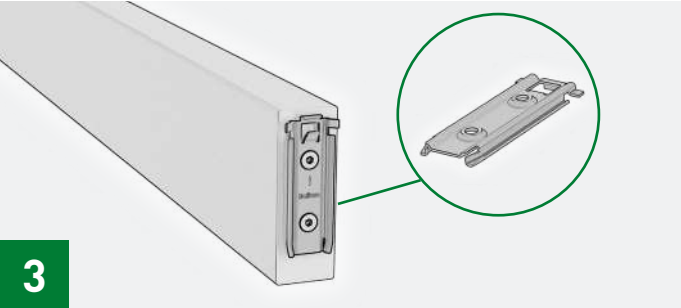
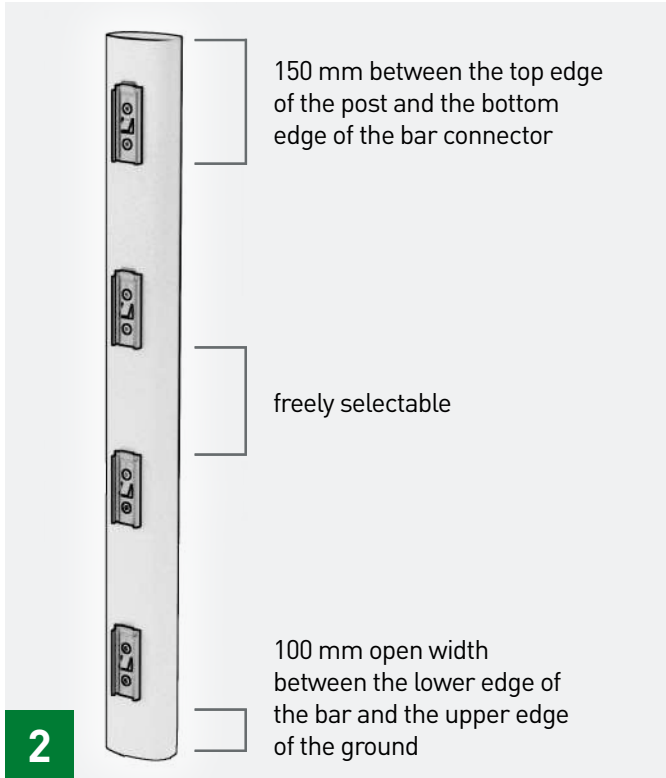
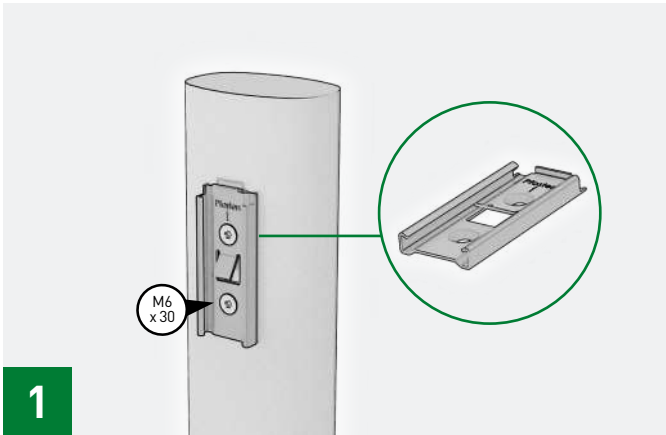

A material for the future.
A material that lasts the course.

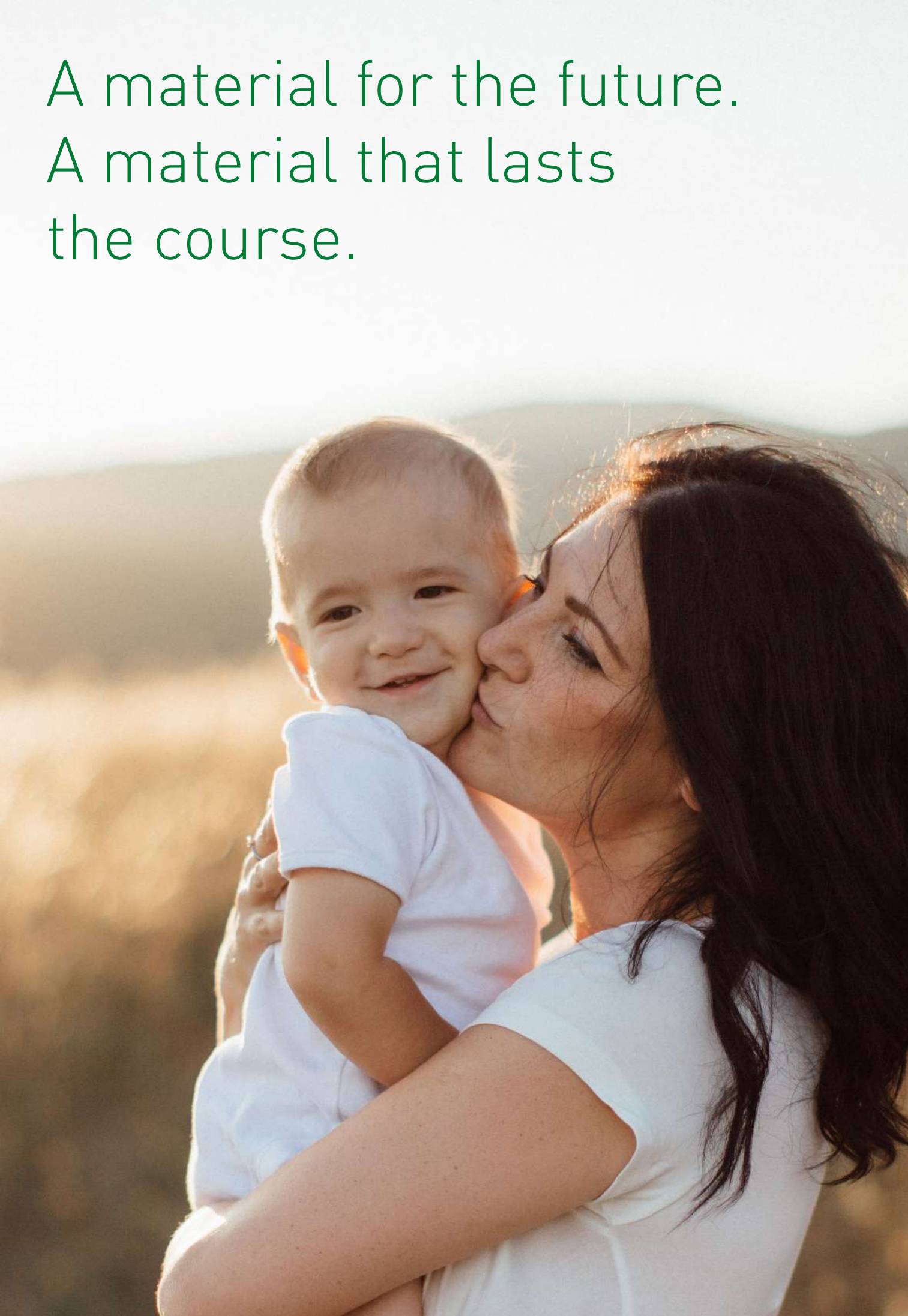

Imprint



Publisher:
NOVO-TECH Trading GmbH & Co. KG
Siemensstraße 31, 06449 Aschersleben, Germany

Concept/design/layout/images:
FULLHAUS GmbH, Regensburg

Subject to change.

We assume no liability for printing errors.

**Colours and graphics may differ from the original
due to technical reasons.**

Status:

1st Edition 02/2025 | EN



Your retailer



EasyDeck[®]
Made in Germany